

99147

Dimensions

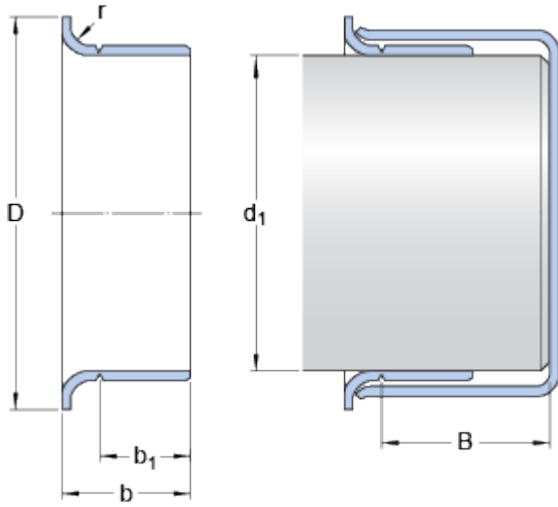

Nominal dimensions

d_1		38	mm
D		45.237	mm
Tolerance outside diameter D	\pm	1.6	mm
b		16.993	mm
Tolerance width b	\pm	0.8	mm
b_1		13.005	mm
Tolerance width b_1	\pm	0.8	mm
B	max.	24.994	mm
r	max.	3.18	mm

Shaft diameter range

d_1	min.	37.846	mm
d_1	max.	37.998	mm